



MN2400

Size: AAA (LR03)

Alkaline-Manganese Dioxide Battery

Zn/MnO₂



Nominal Voltage:	1.5 V
Operating Voltage	1.6 - 0.75V
Impedance:	250 m-ohm @ 1kHz
Typical Weight:	11 gm (0.4 oz.)
Typical Volume:	3.5 cm ³ (0.2 in. ³)
Terminals:	Flat
Storage Temperature Range:	-20°C to 35°C
Operating Temperature Range:	-20°C to 54°C (-4°F to 130°F)
ANSI:	24A
IEC:	LR03

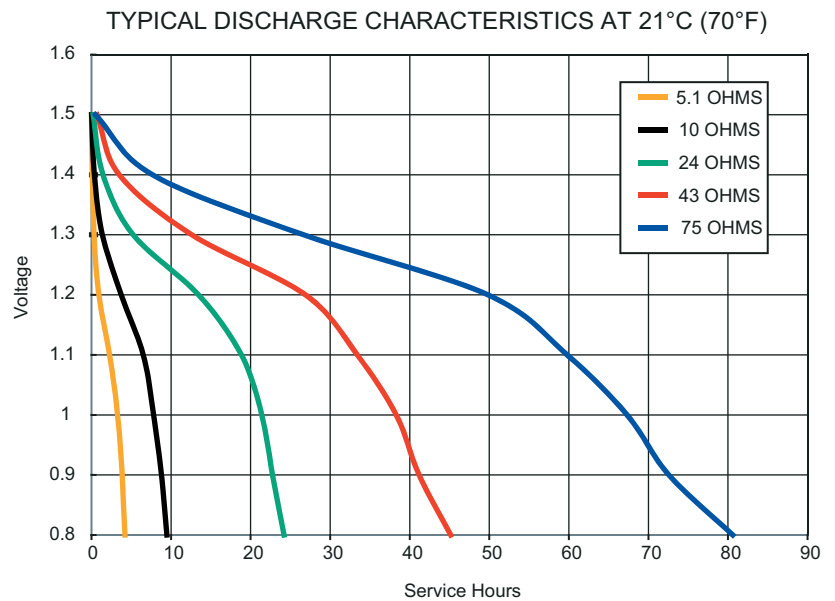
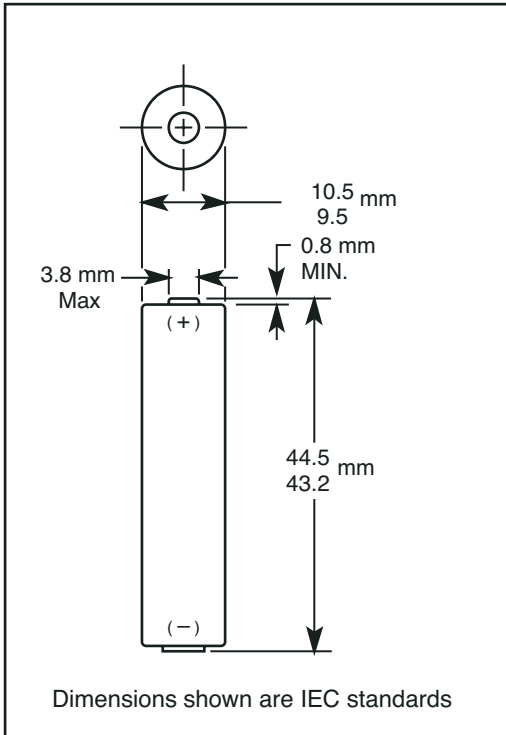

DURACELL[®]
BATTERIES

Berkshire Corporate Park
Bethel, CT 06801 U.S.A.
Telephone: Toll-free 1-800-544-5454
Internet: www.duracell.com

* Delivered capacity is dependent on the applied load, operating temperature and cut-off voltage. Please refer to the charts and discharge data shown for examples of the energy / service life that the battery will provide for various load conditions.



MN2400

Size: AAA (LR03)

Alkaline-Manganese Dioxide Battery

Zn/MnO₂

TYPICAL CONSTANT CURRENT DISCHARGE CHARACTERISTICS AT 21°C (70°F)

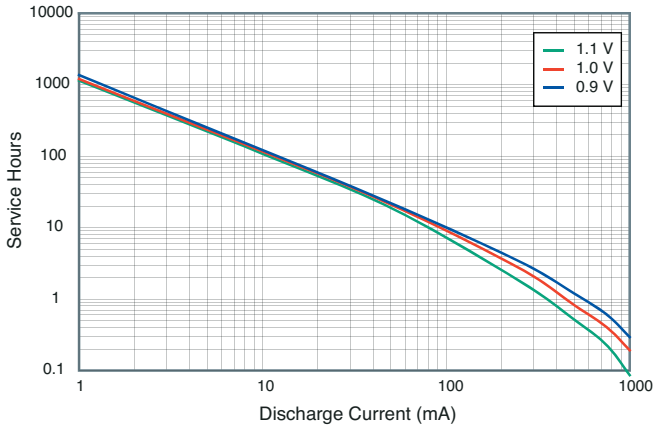

TYPICAL DISCHARGE CHARACTERISTICS AT 21°C (70°F)

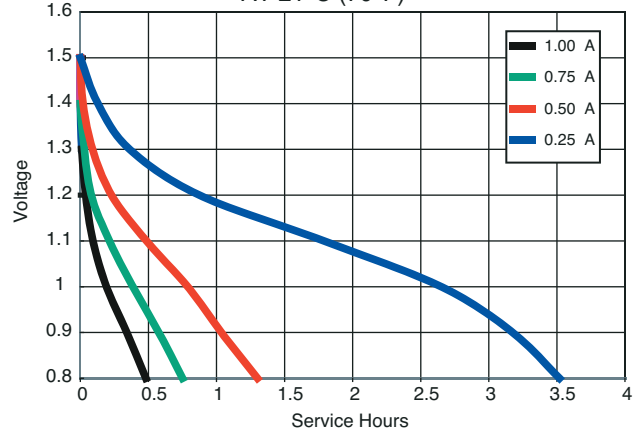

TYPICAL DISCHARGE CHARACTERISTICS AT 21°C (70°F)

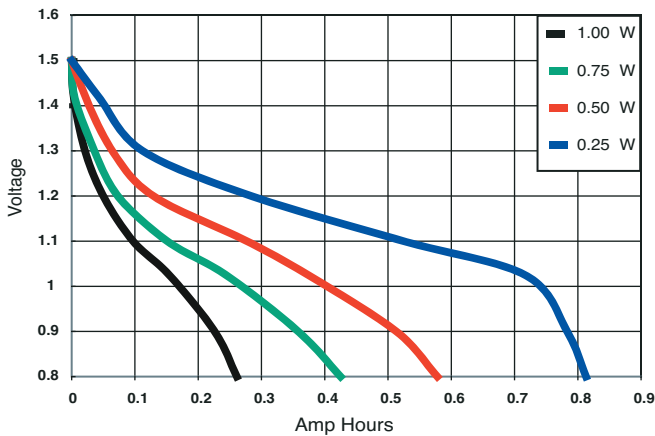

TYPICAL DISCHARGE PERFORMANCE AT 21°C (70°F)

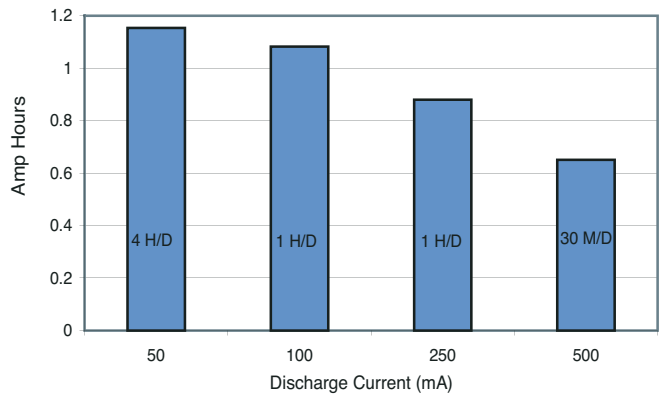

TYPICAL DC RESISTANCE CHARACTERISTICS AT 21°C (70°F)

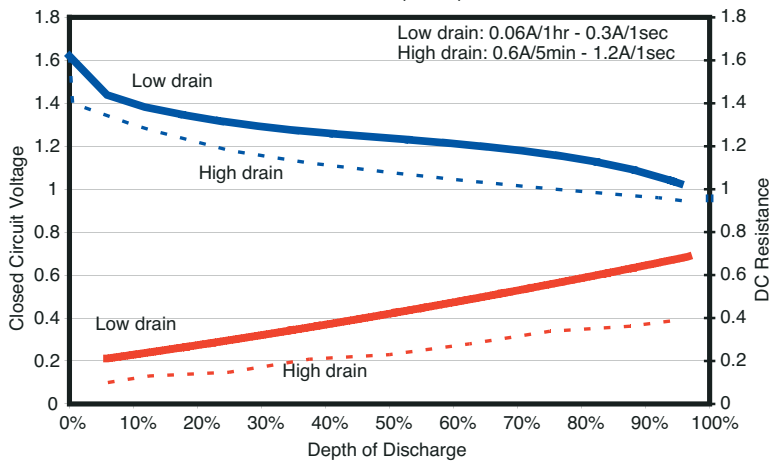

DURACELL[®]
BATTERIES

Berkshire Corporate Park
Bethel, CT 06801 U.S.A.
Telephone: Toll-free 1-800-544-5454
Internet: www.duracell.com

* Delivered capacity is dependent on the applied load, operating temperature and cut-off voltage. Please refer to the charts and discharge data shown for examples of the energy / service life that the battery will provide for various load conditions.